

CITROEN

CITROEN

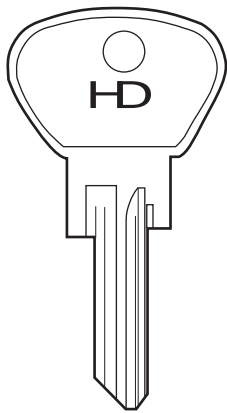

VC24
C213

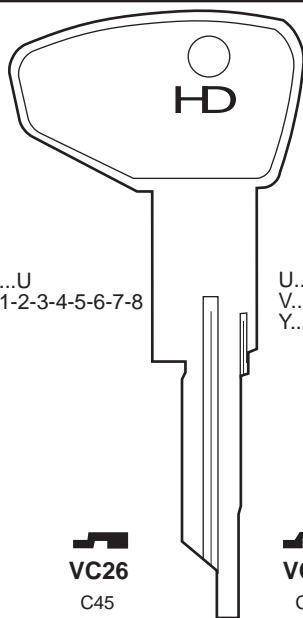

...U
1-2-3-4-5-6-7-8

VC26
C45

U...U 1-2-3-5-7
V...U 1-2-3-5-7
Y...U 1-2-3-5-7

VC30
C47

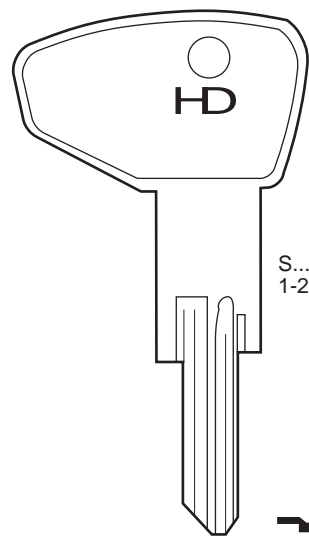

S...S
1-2-3-4-5-6-7-8

VC27
C46

CITROEN

DAEWOO

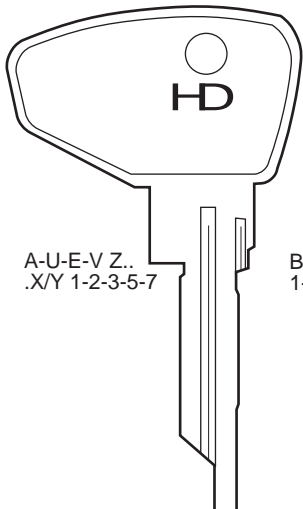

A-U-E-V Z..
.X/Y 1-2-3-5-7

B-T...
1-2-3-5-7

VC35
C49

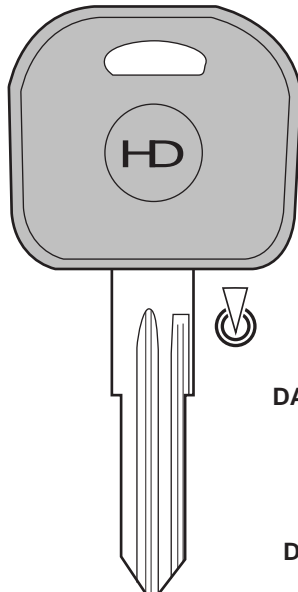

VC25
C44

VC31
C48

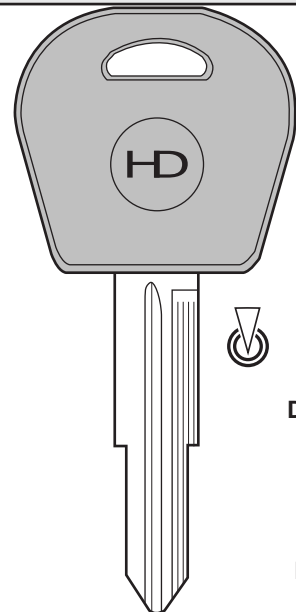

DAE46STK1

DAE46TK1





DAE47STK1
V...1-1200

DAE47TK1
V...1-1200

DAEWOO

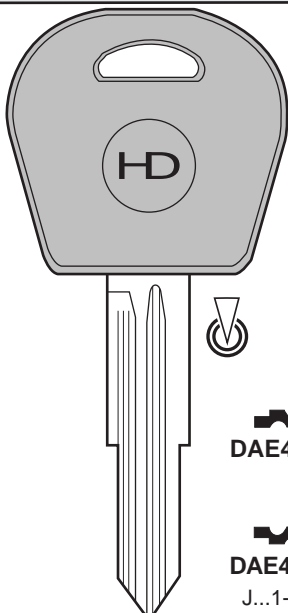
DAEWOO





DAE48TK1

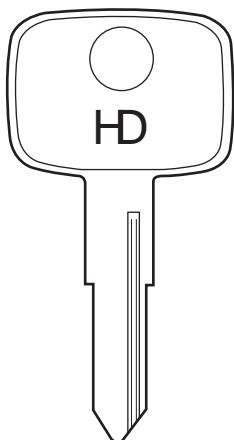

DAE48STK1
J...1-1200

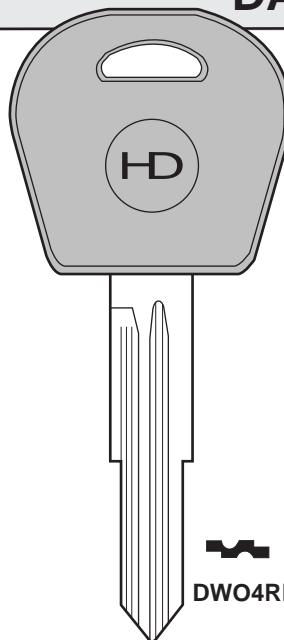

DW02



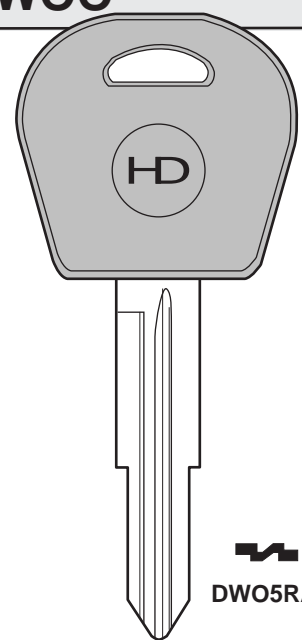

DW04RP



DW05RAP

DAEWOO

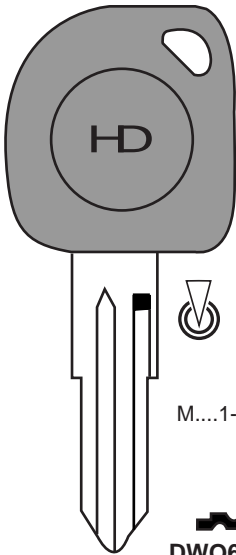
DAF



M... 1-1200

DWO6BT5
TP092

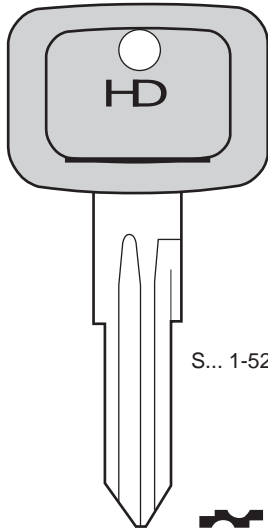

S... 1-5200

HF58RP
PT004

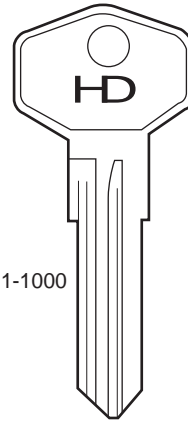

AK... 1-1000

AK
C71

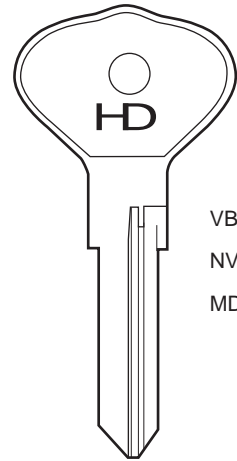

VB... 2001-2830
3001-3890
NV... 2001-2830
3001-3890
MD... 2001-2830
3001-3890

CA1
C149

DAF

DAF

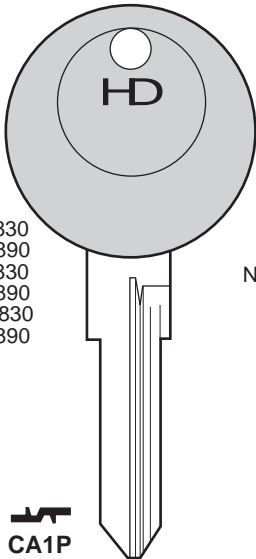

VB... 2001-2830
3001-3890
NV... 2001-2830
3001-3890
MD... 2001-2830
3001-3890

CA1P
PT017



N... 101-200

CA2
C158

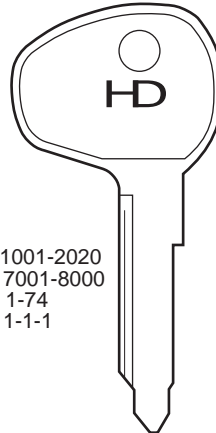

X... 1001-2020
7001-8000
..X... 1-74
1-1-1

HF41
C159

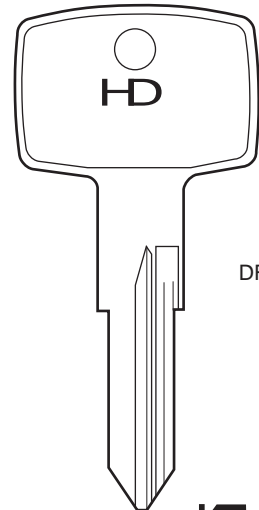

DF-F... 1-1975

HF46
C160

DAF

DAF

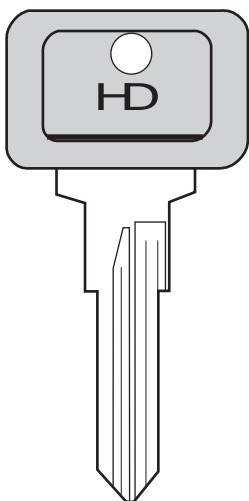

HF46P
PT002

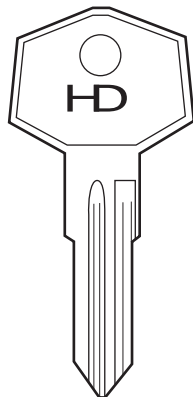

KA
C161

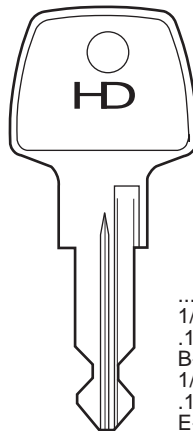

NE34
C104

...A/Z B-C-D-E
.1/9...A/Z
.1/9...A/Z
B-D-E-G-H-J
.1/9...A/Z
.1/9...A/Z
E-M-N-P-R

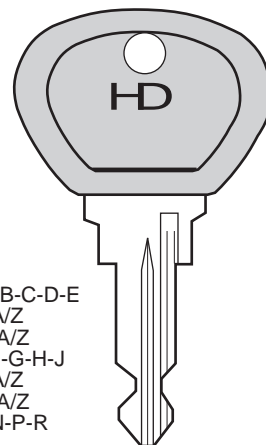

NE34P
PT014

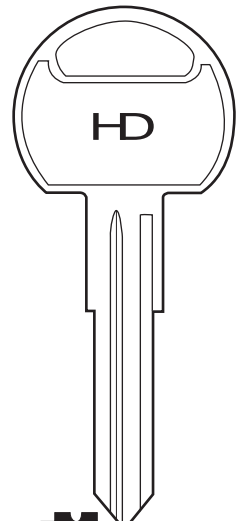

NE38

DAEWOO

DAF

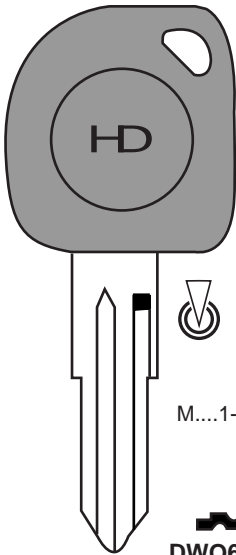

M... 1-1200

DWO6BT5
TP092

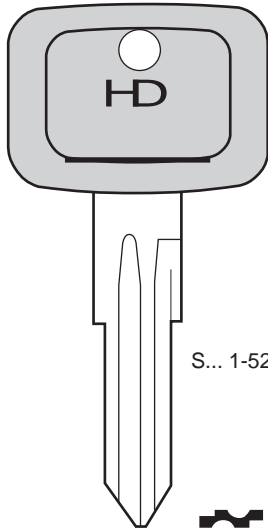

S... 1-5200

HF58RP
PT004

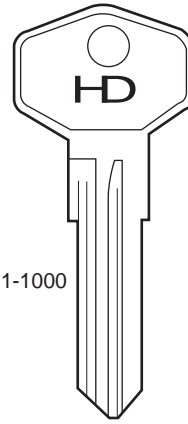

AK... 1-1000

AK
C71

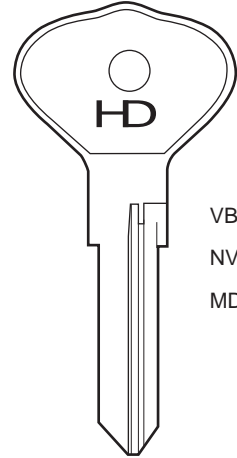

VB... 2001-2830
3001-3890
NV... 2001-2830
3001-3890
MD... 2001-2830
3001-3890

CA1
C149

DAF

DAF

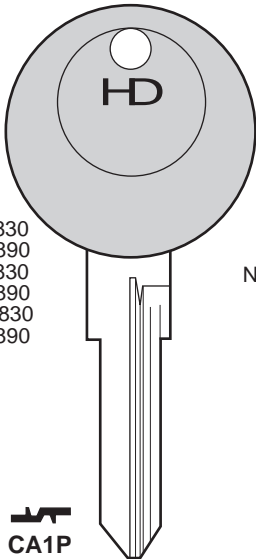

VB... 2001-2830
3001-3890
NV... 2001-2830
3001-3890
MD... 2001-2830
3001-3890

CA1P
PT017

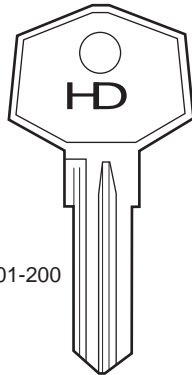

N... 101-200

CA2
C158

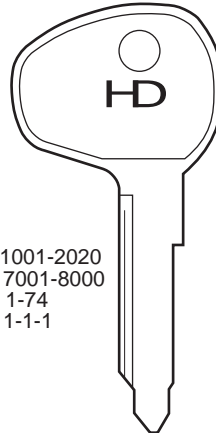

X... 1001-2020
7001-8000
..X... 1-74
1-1-1

HF41
C159

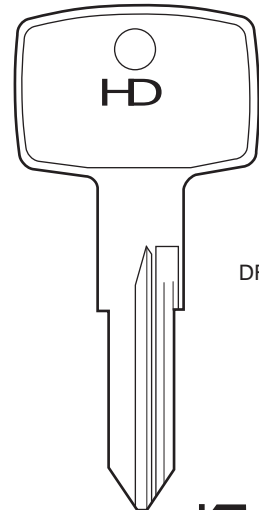

DF-F... 1-1975

HF46
C160

DAF

DAF

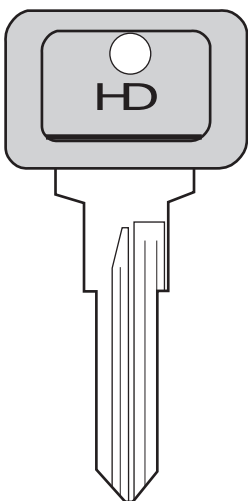

HF46P
PT002

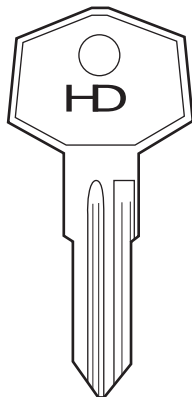

KA
C161

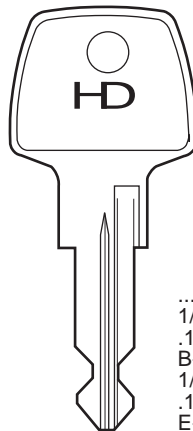

NE34
C104

...A/Z B-C-D-E
.1/9...A/Z
.1/9...A/Z
B-D-E-G-H-J
.1/9...A/Z
.1/9...A/Z
E-M-N-P-R

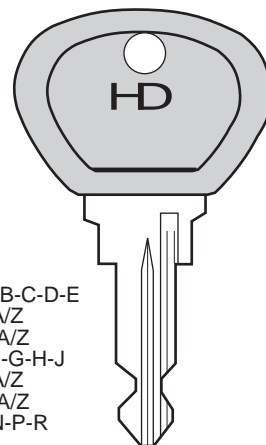

NE34P
PT014

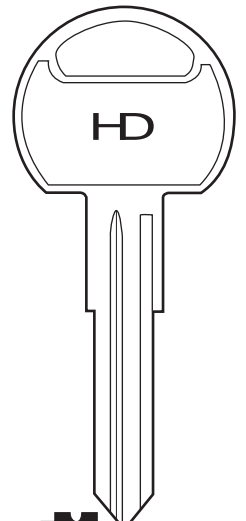

NE38

DAF

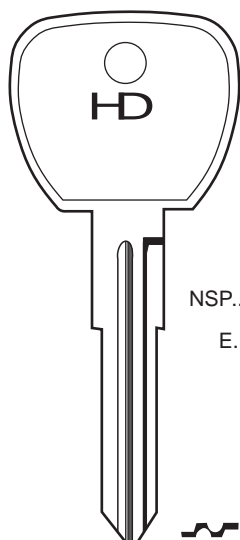

NE48
C249

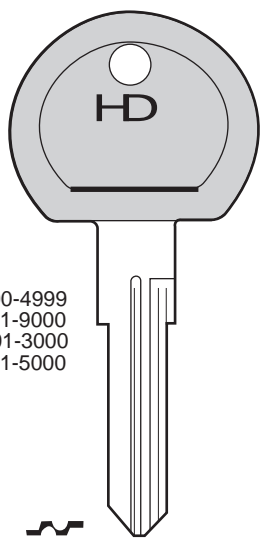

NE48P
PTO16

NSP... 4000-4999
7001-9000
E... 2001-3000
4001-5000

DAIHATSU

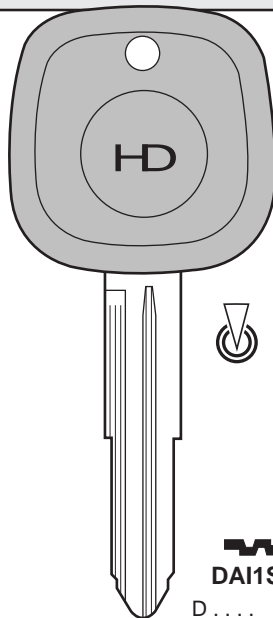

DAI1STK3

D.... 1-2000

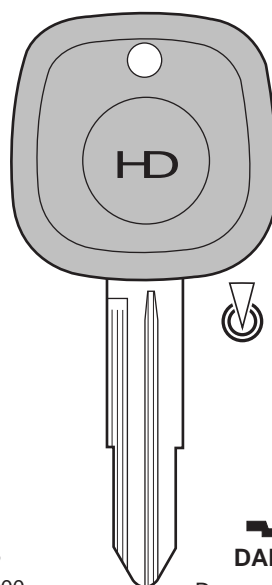

DAI4STK3

D.... 1-3001-4000

DAIHATSU

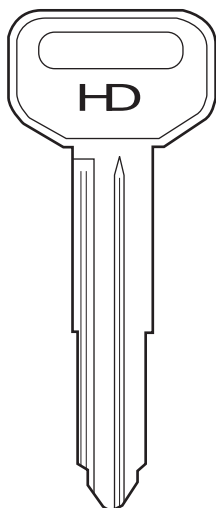

DH4R
C401

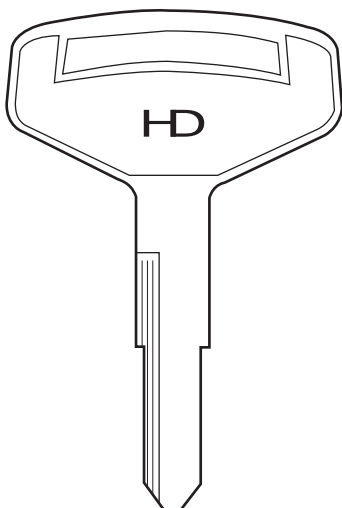

DH3R

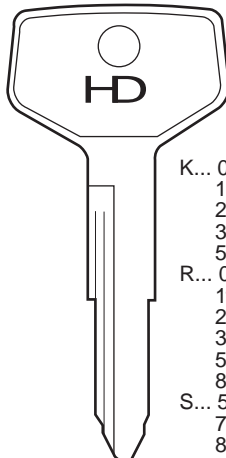

TA17
C126

K... 0001-1400
1511-1910
2221-2620
3731-4400
5001-6368
R... 0401-0800
1112-1510
2621-3020
3331-3730
5001-6924
8001-9368
S... 5951-6350
7061-7460
8171-8570
9281-9680
C... 6001-7042 (ISUZU)

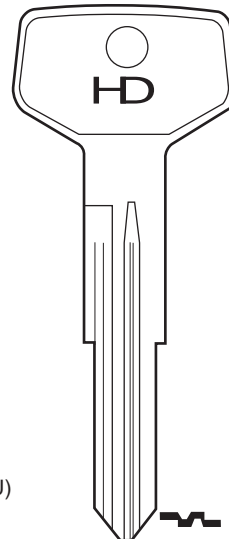

TT22
C135

DAIHATSU

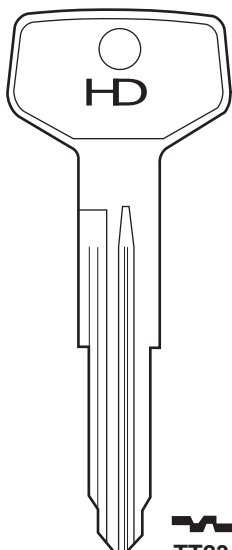

TT23
C281

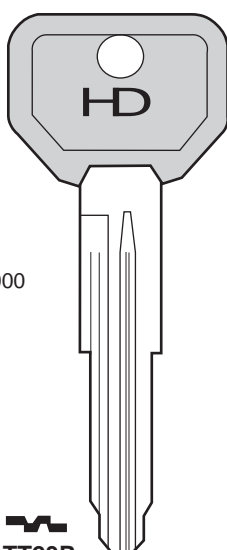

TT23P
PT039

K... 7001-9000

FERRARI

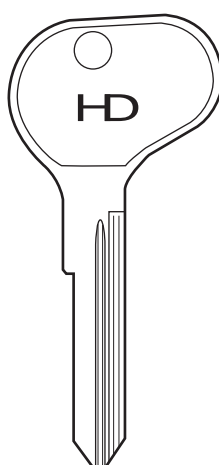

BW3

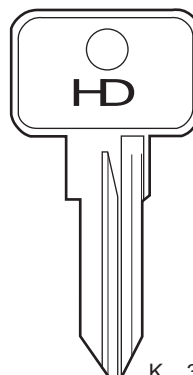

K
C60

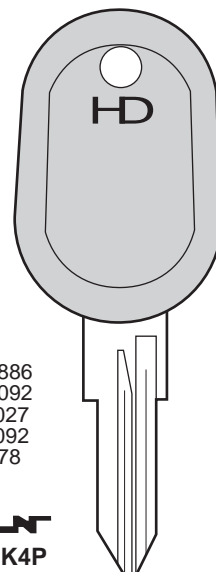

K4P
PT007

K... 3301-4886
K... 7001-8092
T... 5000-6027
T... 7001-8092
S... 501-3278

FERRARI

FERRARI

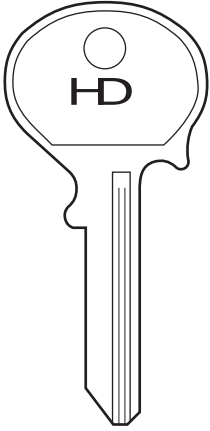

...A
1-2-3-4-5

NE7
C28

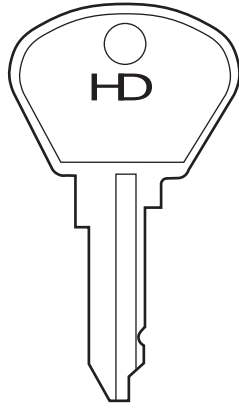

AZ...1-2-3-5-7-
A/Z 0-4-6-8-9

NE9
C64

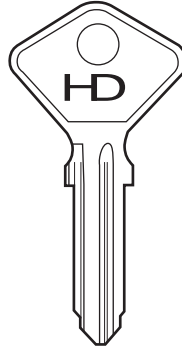

2...100-309

SF1
C2

4...100-309

SF2
C3

6...100-309

SF3
C4

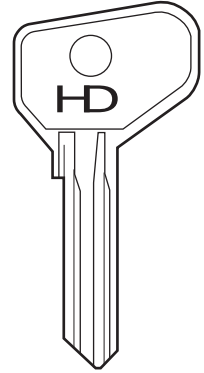

1... 501-1000

SF5
C66

3... 501-1000

SF6
C67

FIAT/IVECO

FIAT/IVECO

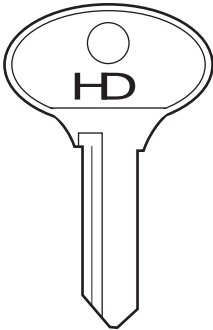

G... 01-78

63SG

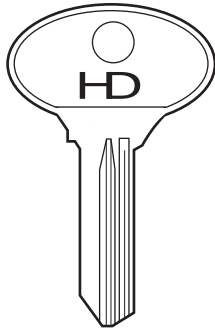

H... 01-78

63SH

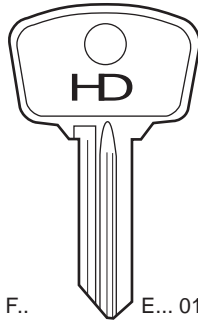

F.. E... 01-78

63SP

R63SP

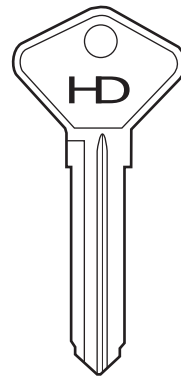

AF3A

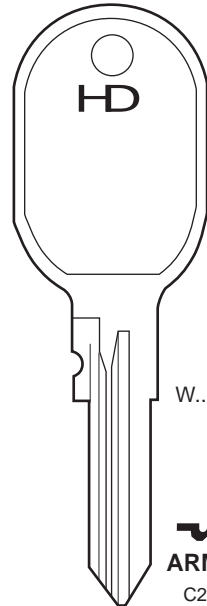

W... 0001-9640

ARM10
C246

FIAT/IVECO

FIAT/IVECO

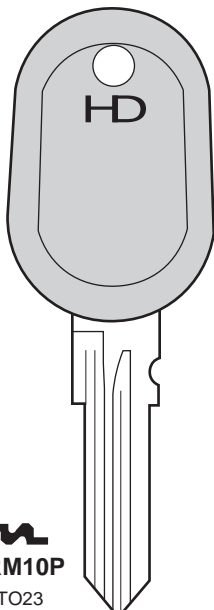

ARM10P
PTO23

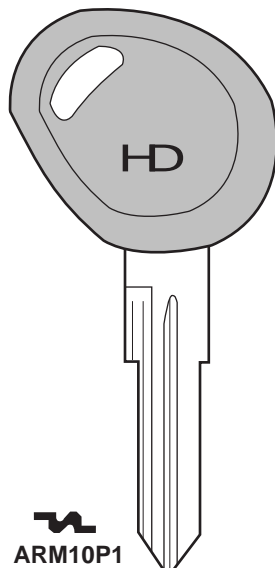

ARM10P1
PTO56

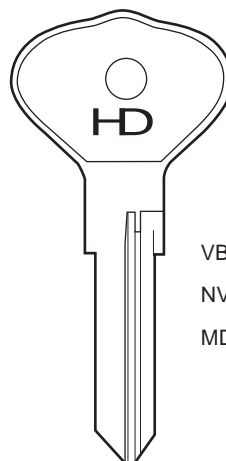

CA1
C149

VB... 2001-2830
3001-3890
NV... 2001-2830
3001-3890
MD... 2001-2830
3001-3890

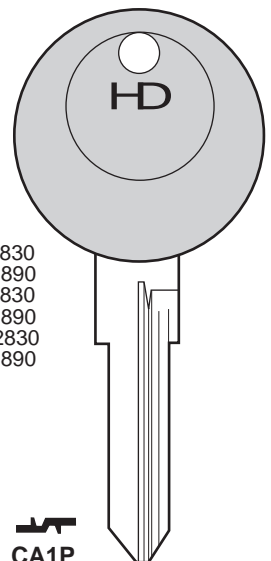

CA1P
PT017

FIAT/IVECO

FIAT/IVECO

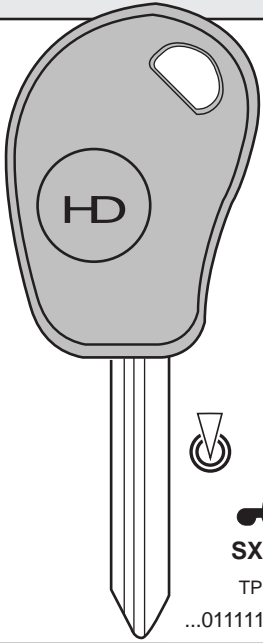

SX9T5
TP059
...0111111-628888

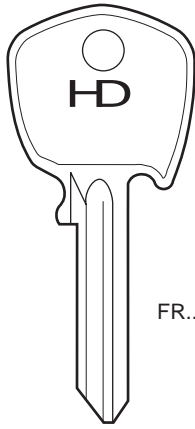

DM5
C37

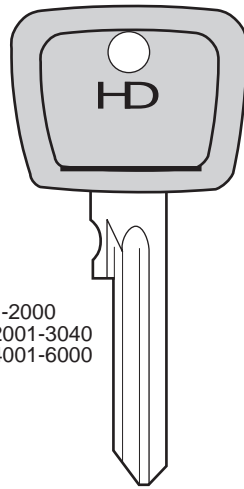

FR... 1-2000
2001-3040
4001-6000
DO1P
PTO20

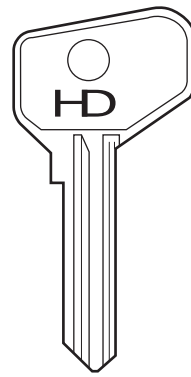

Z... 100-309
FA1
C170

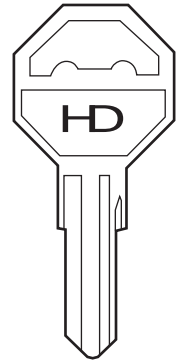

FA3R

FIAT/IVECO

FIAT/IVECO

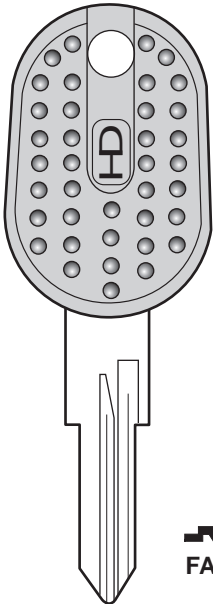

FA6P

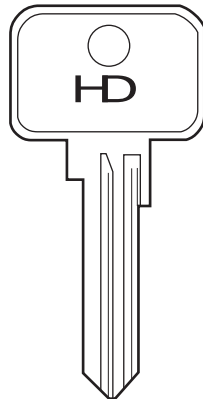

FB4
C174

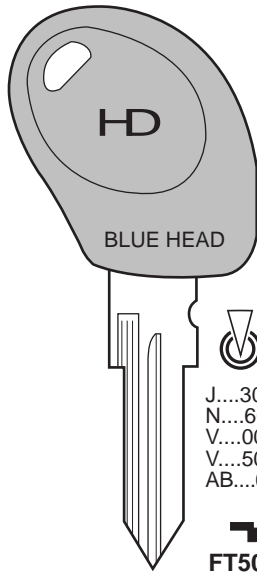

J...3001-6732
N...6001-7000
V...0001-3056
V...5001-8058
AB...6001-6891
FT50ATK5
TP517

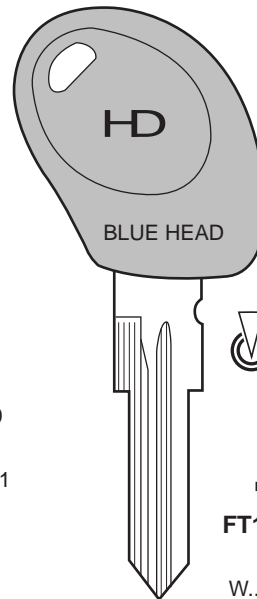

FT1505ATK5
TP515
W...001-9640

FIAT/IVECO

FIAT/IVECO

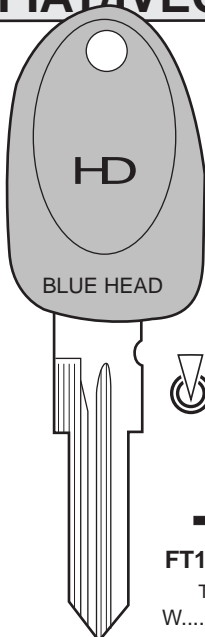

FT1505TK1
TP516
W...001-9640

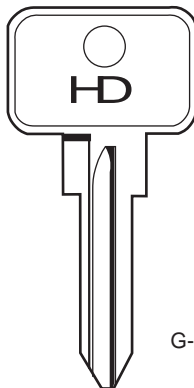

G
C59

G-Z... 7001-9956

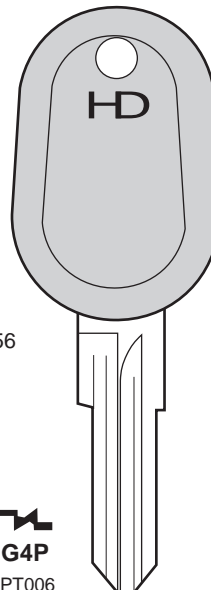

G4P
PT006

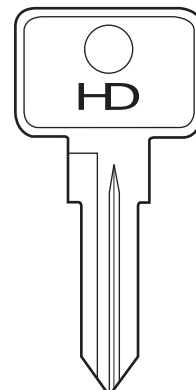

GT8

FIAT/IVECO

FIAT/IVECO

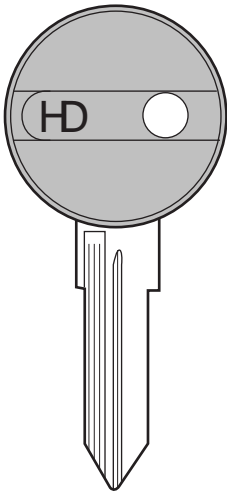

GT11CP

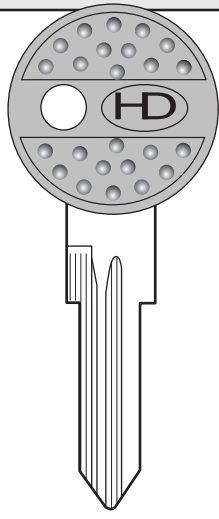

GT17RCP

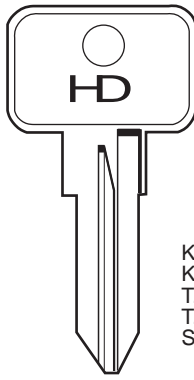

K
C060

K... 3301-4886
K... 7001-8092
T... 5000-6027
T... 7001-8092
S... 501-3278

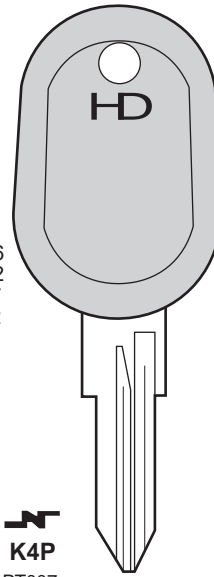

K4P
PT007

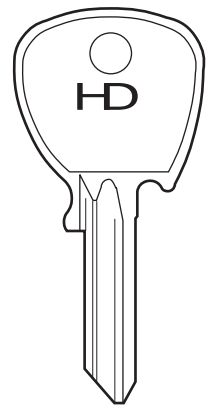

0001-2000
L
C61

FIAT/IVECO

FIAT/IVECO

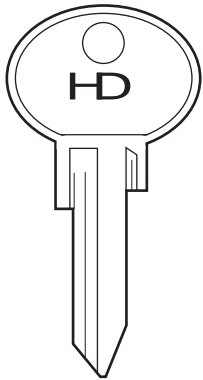

0001-1050
M
C62

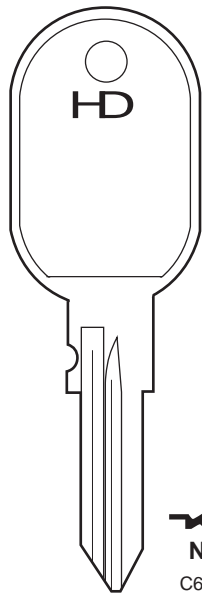

N
C63

6001-7000

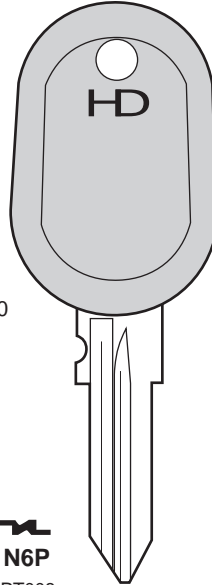

N6P
PT008

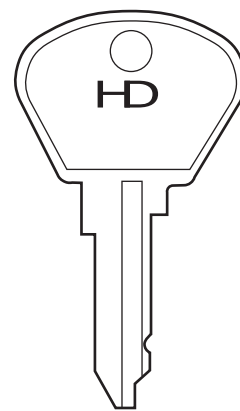

AZ...1-2-3-5-7-
A/Z 0-4-6-8-9
NE9
C64

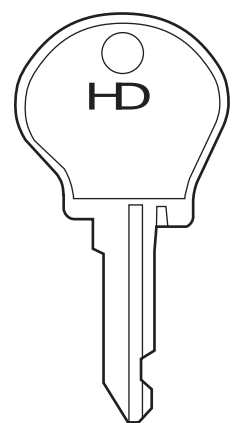

11-34-39... 1-2-3-5-7
34-39...A/Z 1-2-3-5-7
NE13
C65

FIAT/IVECO

FIAT/IVECO

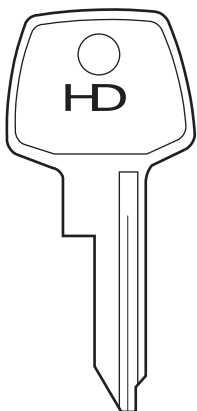

Neiman
W Series
NE20
C116

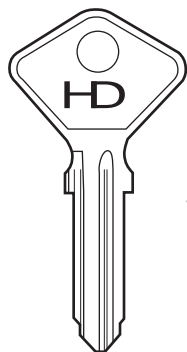

2...100-309
SF1
C2

4...100-309
SF2
C3

6...100-309
SF3
C4

8...100-309
SF4
C5

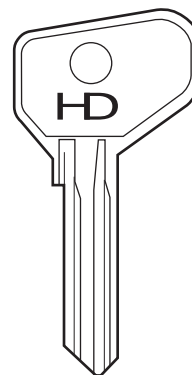

1... 501-1000
SF5
C66

3... 501-1000
SF6
C67

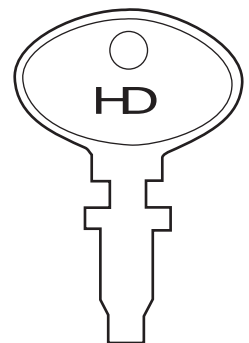

SFA1

FIAT/IVECO

FIAT/IVECO

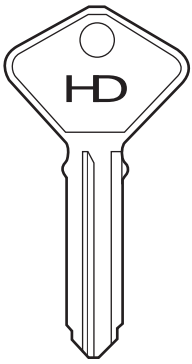

SFAB1

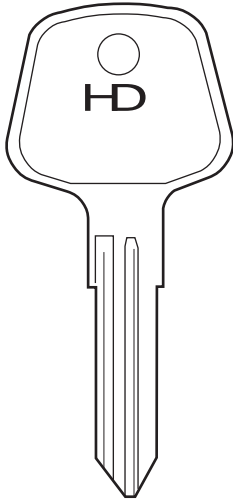

SIP14
C317

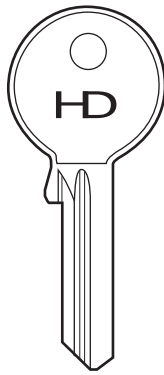

WS6

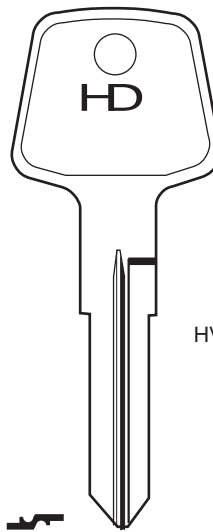

WT9
C157

HV...1-9282 VB.VH

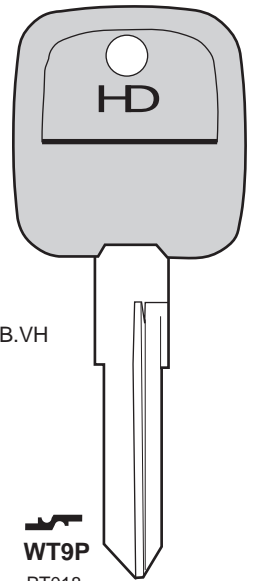

WT9P
PT018

FIAT/IVECO

FORD

UK/GERMANY

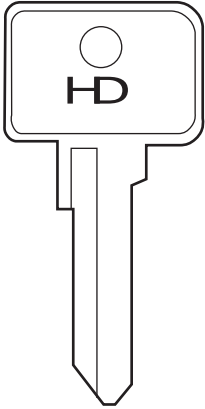

X
C68

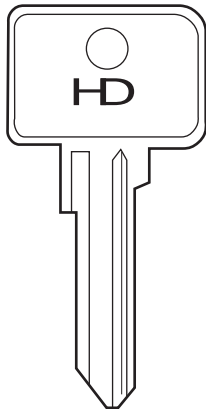

7001-9956
Y
C69

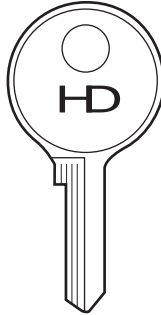

62VC



FD-FH-FJ
FK-FV-FW
FX-FY-NH
NK-NW-NY
HY-W
000-999

BA7R

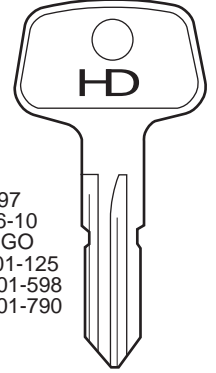

124-197
G... 06-10
OGI-1GO
A... 101-125
501-598
701-790

BLA2
C169

FORD

UK/GERMANY

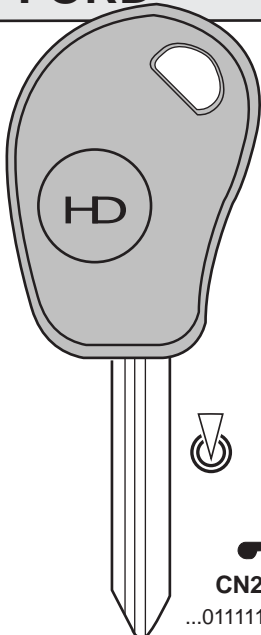

CN22TK1
...0111111-628888

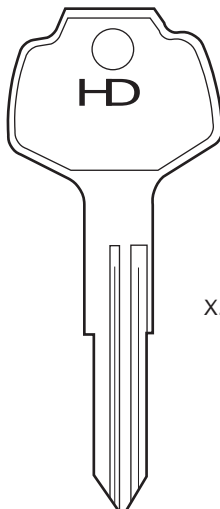

DT23
C56

X... 001-8000
8001-9000

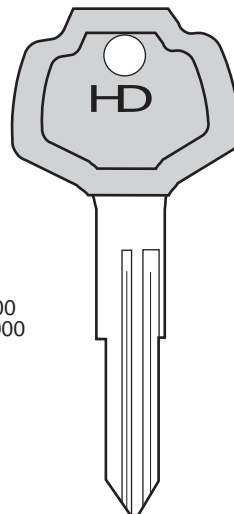

DT23P
PTO22

C... 1-2-3-4-5

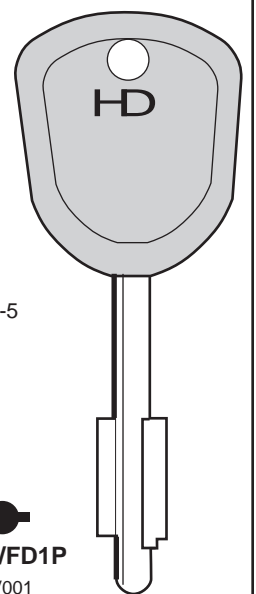

FAV1/FD1P
CV001

FORD

UK/GERMANY

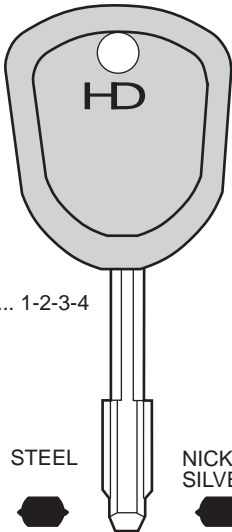

T... 1-2-3-4

STEEL



FAV2 S

CV025

NICKEL SILVER



FAV2 N

CV002

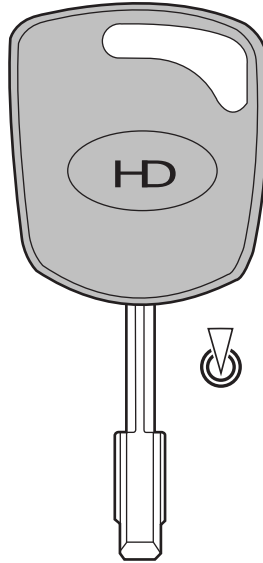

BLUE DOT



FO21T7

CV034

RED TOP MASTER



FAV3TP

CV048

RED DOT



FAV2TP

CV024

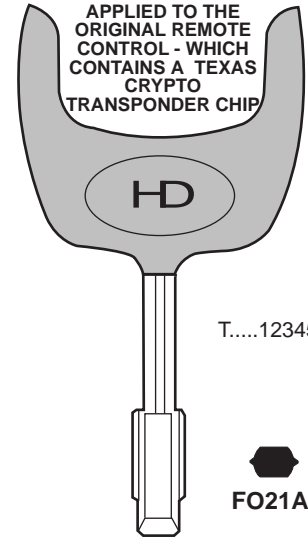

HORSE SHOE KEY
BLANK TO BE
APPLIED TO THE
ORIGINAL REMOTE
CONTROL - WHICH
CONTAINS A TEXAS
CRYPTO
TRANSPONDER CHIP

T.....12345



FO21AP

FORD

UK/GERMANY

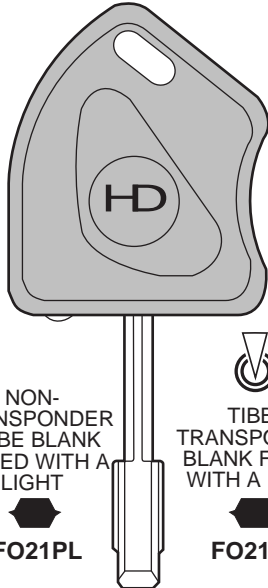

NON-
TRANSPONDER
TIBBE BLANK
FITTED WITH A
LIGHT



FO21PL

TIBBE
TRANSPONDER
BLANK FITTED
WITH A LIGHT



FO21T3L

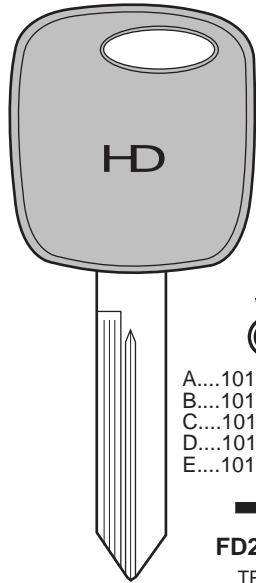

A....101-291.501-579
B....101-332.501-602
C....101-344.501-624
D....101-327.501-602
E....101-296-501-579



FD21TK2

TP513

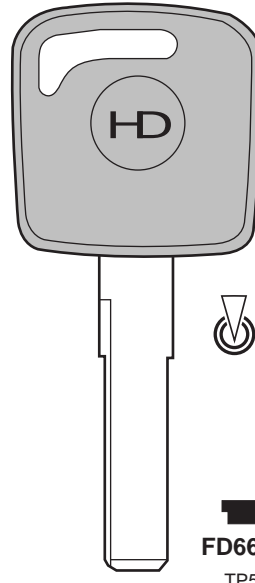

FD66TK1

TP514

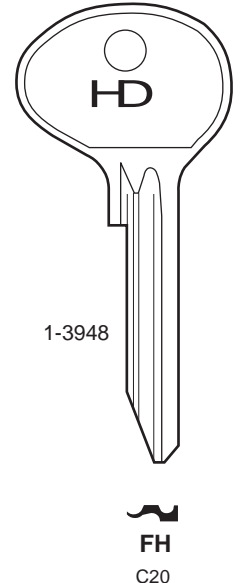

1-3948



FH

C20

FORD

UK/GERMANY

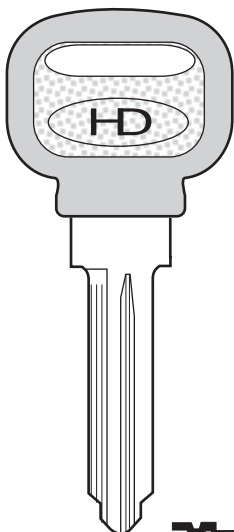

FO22RP

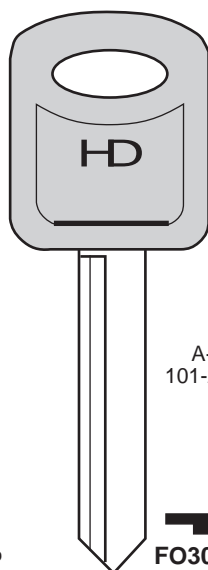

A-B-C-D-E-
101-291,501-579

FO30BP

PT058

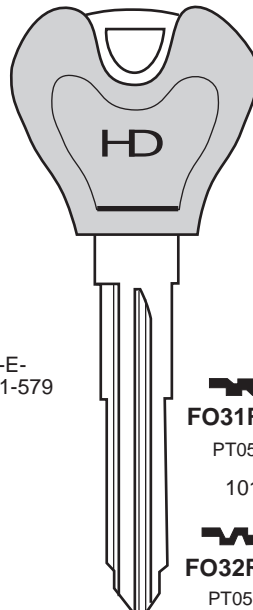

FO31RAP

PT054

10100-12099

FO32RAP

PT057

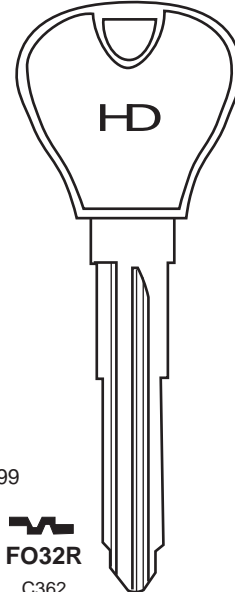

FO32R

C362

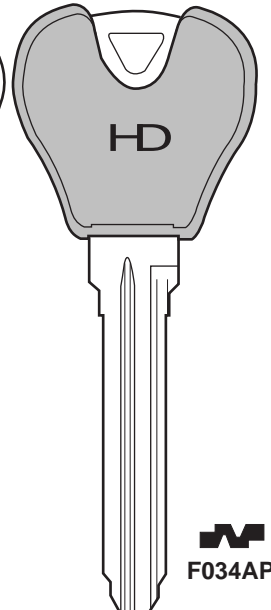

FO34AP

FORD

UK/GERMANY

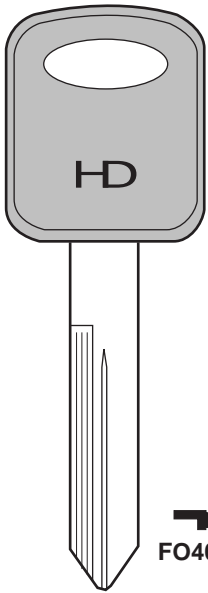

FO40RBP

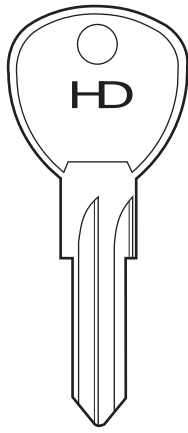

FOT5 FOT5R



001-099
876-955

FS
C24

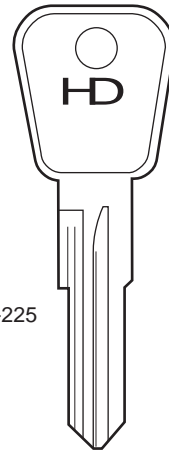

101-225

FT/FV
C70

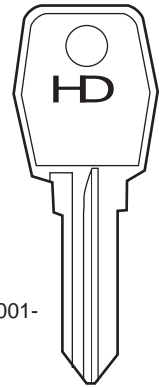

1001-

FT TF
C38 C74

FORD

UK/GERMANY

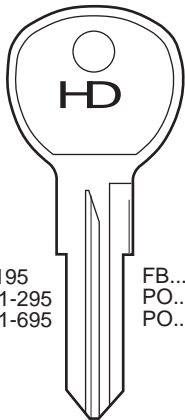

ER... 1-195
101-295
501-695

FB... 1-210
PO... 501-695
PO... 1-295

H62FD HR62FD
C341 C342

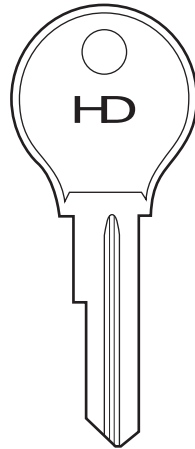

HU1R

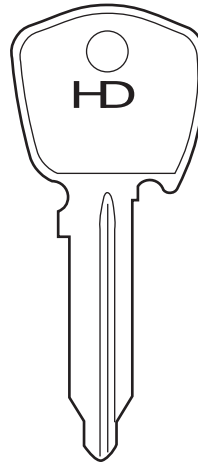

KL2
C18

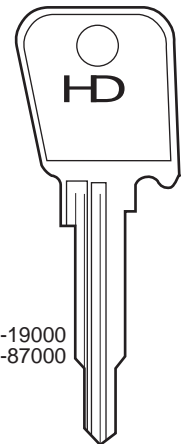

15001-19000
85001-87000

LF4
C19

FORD

UK/GERMANY

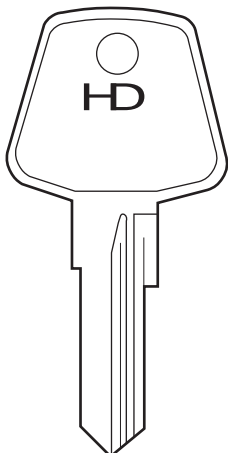

LF19
C287

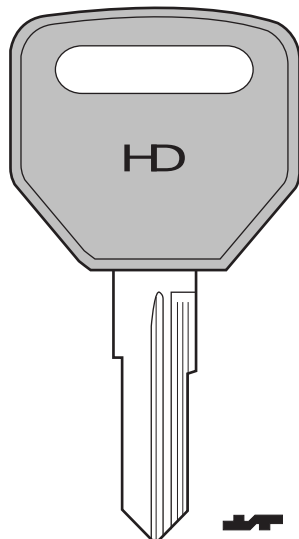

LF21RCP

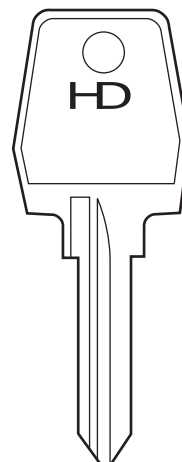

LF29
C271

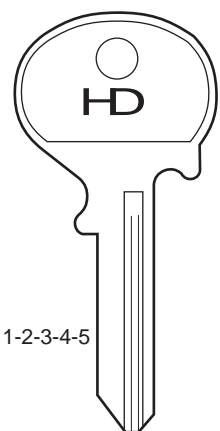

...A 1-2-3-4-5

NE7
C28

FORD

UK/GERMANY

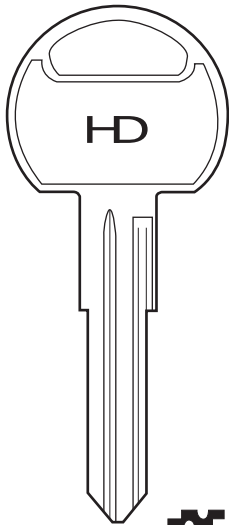

NE38

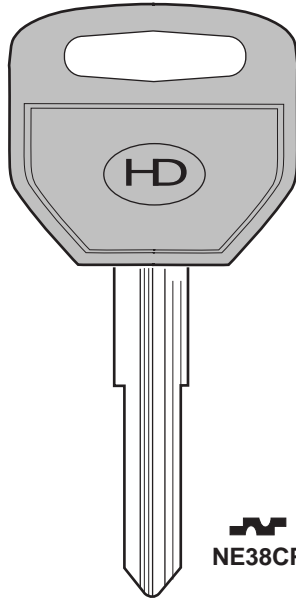

NE38CP

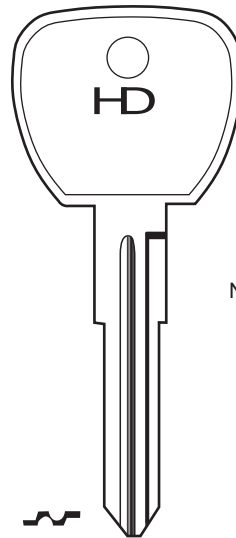

NE48
C249

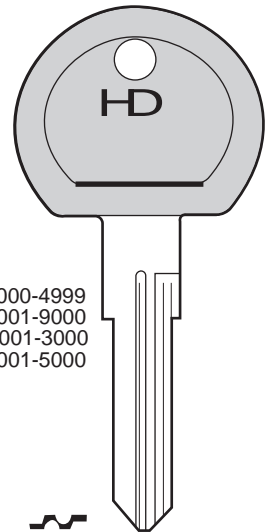

NSP... 4000-4999
7001-9000
E... 2001-3000
4001-5000

NE48P
PTO16

FORD

UK/GERMANY

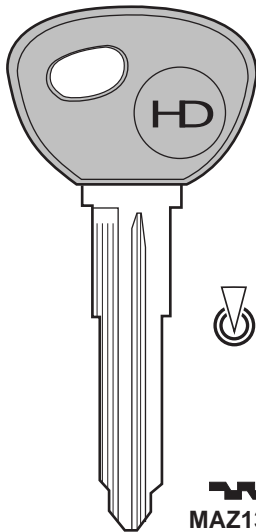

MAZ13T5
TP026
....10100-12283

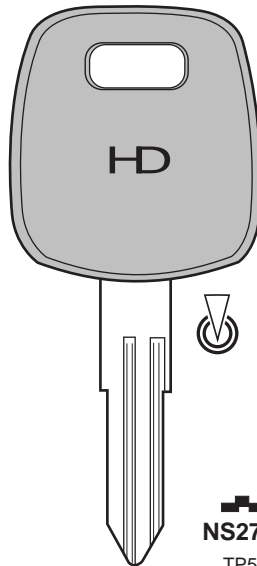

NS27TK1
TP525
X...1-8000

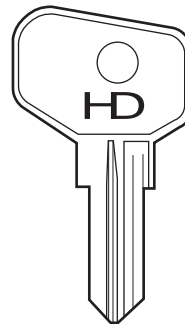

101-179

PR1
C173

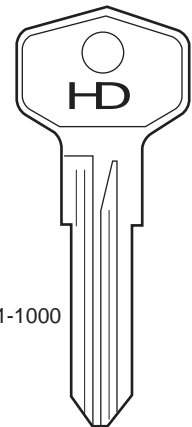

1-1000

TC/AK
C71

FORD

UK/GERMANY

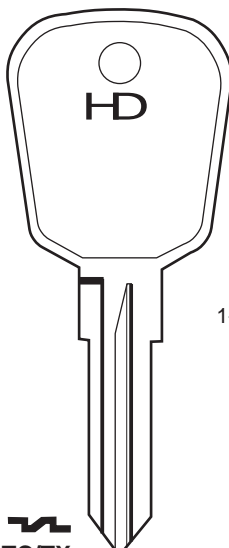

TC/TX
C73

1-1859

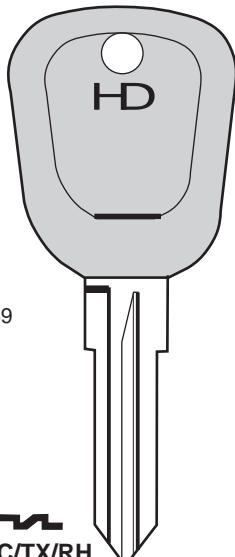

TC/TX/RH
C72

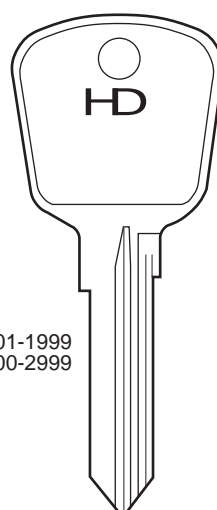

1001-1999
2000-2999

WB2
C75

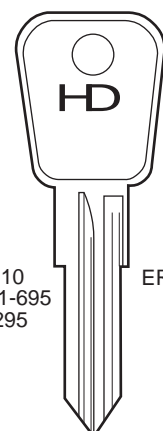

FB... 1-210
PO... 501-695
PO... 1-295

YM20
C343

ER... 1-195
101-295
501-695

YM26
C324

FORD

USA

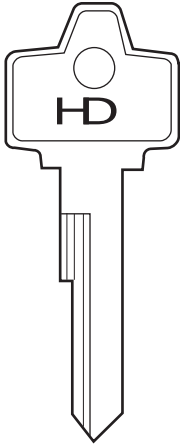

FE... 1-1000

1127MU
 C359

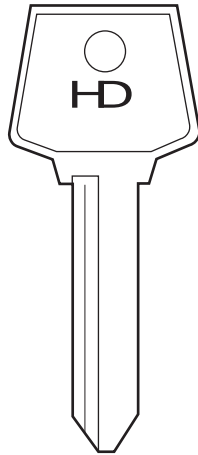

FA... 000-1863

1127TB
 C372

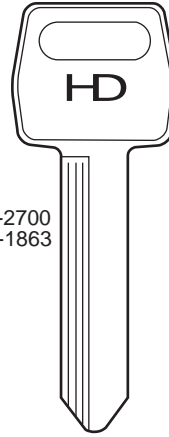

AF... 1-2700
 FA... 1-1863
 PA...

1167FD
 C376

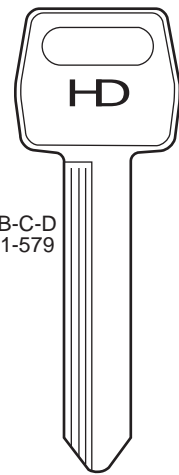

A-B-C-D
 101-579



1184FD
 C378

FORD

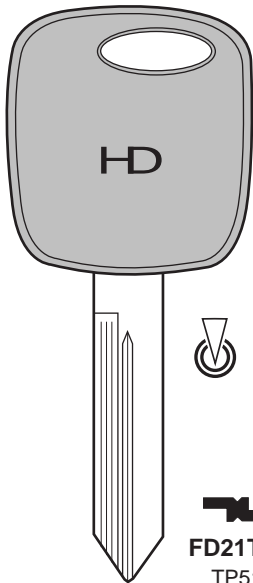
USA



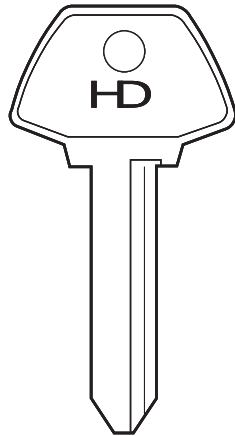

FD21TK2
 TP513

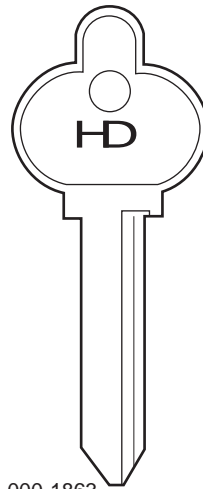

FB... 000-1863

S1127FD
 C373



FB... 000-1863

S1127ME
 C374

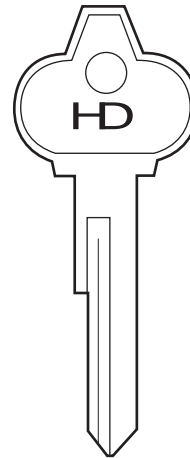

FN... 1-1000

S1127MU
 C375

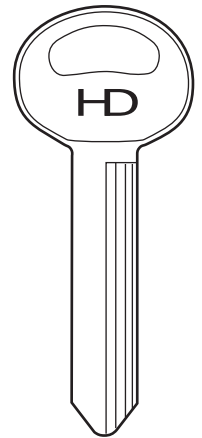

FB... 1-1863
 PB... 1-1863

S1167FD

GENERAL MOTORS

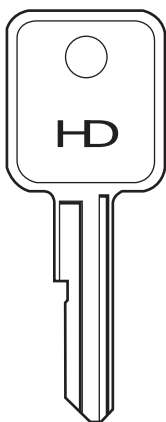
GENERAL MOTORS

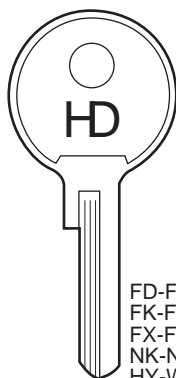

8000-9499 225-814

BA2 **BA2R**

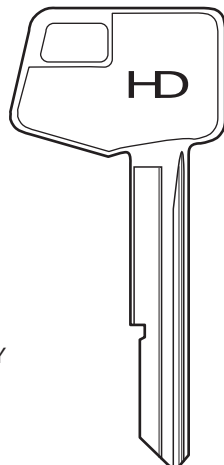

FD-FH-FJ
 FK-FV-FW
 FX-FY-NH
 NK-NW-NY
 HY-W
 000-999

BA7R



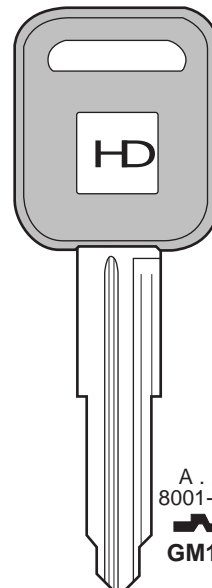

GM9

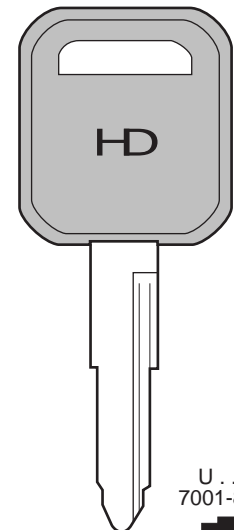

A.....
 8001-9400

GM11P



U.....
 7001-8200

GM23P